

Losse
producten

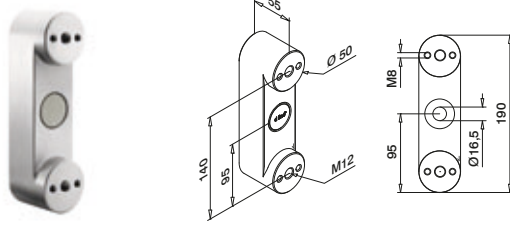

Blok adapter



		Glasgestraald
BLOK ADAPTER		
316		
14.9030.010.01		1

NEW

Rubber ring voor glasadapter



		Ø 33
RUBBER RING VOOR GLASADAPTER		
19.5030.034.00	1	8
19.5060.034.00	2	8

Kunststof inlay voor glasadapter

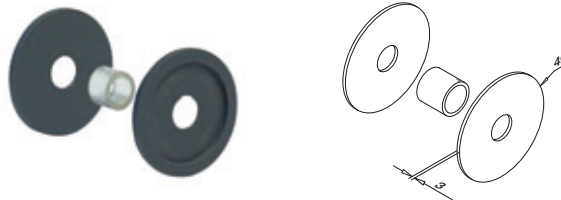

		Ø 49
19.5031.149.00	2	8
19.5032.149.00	1	8

NEW

		Ø 49
KUNSTSTOF INLAY VOOR GLASADAPTER		
19.9037.050.00		4

NEW

Voor Blok Easy Glass

Glasbevestigingsadapter

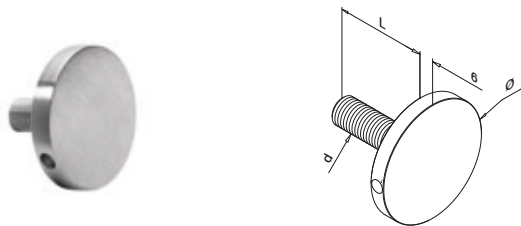

		Geslepen			
GLASBEVESTIGINGSADAPTER					
316	T	L	d		
14.9050.012.12	10-12	21	M8		2
14.9050.016.12	12,76-16	25	M8		2
14.9050.019.12	16,76-20	29	M8		2
14.9050.025.12	21,52-25,52	35	M8		2

		Ø 50			
316	T	L	d		
14.9049.026.12	12-25,52	45	M12		2

NEW

Afstandsschijf

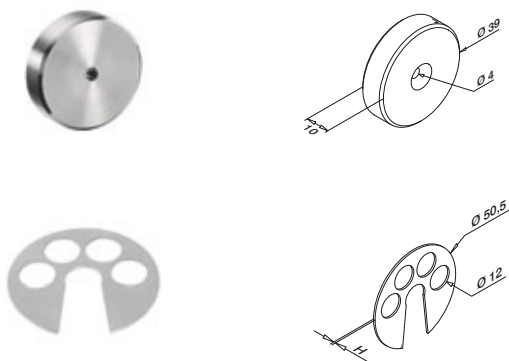

		Ø 39
AFSTANDSSCHIJF		
316	H	
14.9030.015.00	10	2

Voor Blok adapter

		Ø 50,5
316	H	
14.9030.017.00	0,5	2
14.9030.018.00	1,0	2

NEW

Voor Two Point Fixing



Glasadapterplaat

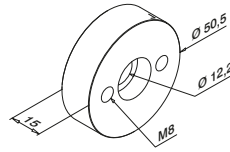

Ø 50,5	Geslepen	
GLASADAPTERPLAAT		
316		
14.9030.020.12		2

NEW

voor Blok Fixing Full Glass

Adapter

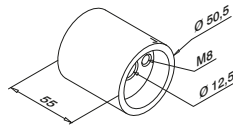

Ø 50,5	Glasgestraald	
ADAPTER		
316		
14.9030.012.01		2

NEW

voor Two Point Fixing

Balustersteun

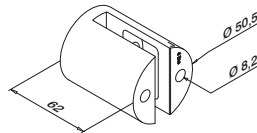

BOVENKANT	Geslepen	
BALUSTERSTEUN		
316		
14.9030.030.12		2

ONDERKANT		
316		
14.9030.025.12		2

NEW

Glasadapter Glass Link

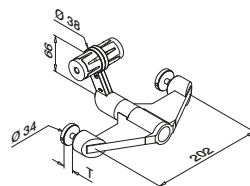

BOVENKANT	Geslepen	
GLASADAPTER GLASS LINK		
316	T	
14.9059.102.12	10-12	1
14.9059.106.12	12,76-16	1
14.9059.109.12	16,76-20	1
14.9059.105.12	21,52-25,52	1

ONDERKANT		
316	T	
14.9059.202.12	10-12	1
14.9059.206.12	12,76-16	1
14.9059.209.12	16,76-20	1
14.9059.205.12	21,52-25,52	1

NEW

Bevestigingsadapter voor glas / handrailingsteun

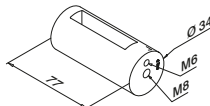

BOVENKANT	Geslepen	
BEVESTIGINGSADAPTER VOOR GLAS / HANDRAILINGSTEUN		
316		
14.9030.035.12		2

NEW

Bevestigingsadapter glas

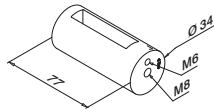

ONDERKANT	Geslepen	
BEVESTIGINGSADAPTER GLAS		
316		
14.9030.037.12		2

NEW

Adapter voor handrailingsteun

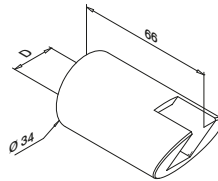
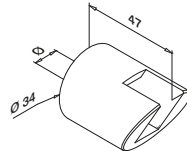

KORT	Geslepen	
ADAPTER VOOR HANDRAILINGSTEUN		
316	Ø	
14.9030.110.12	8,5 voor balusters	2
14.9030.120.12	M8 voor glas	2

LANG	Geslepen	
ADAPTER VOOR HANDRAILINGSTEUN		
316	Ø	
14.9030.115.12	20 voor wand	2

NEW

Rozet voor handrailingsteun

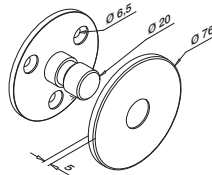

ROZET VOOR HANDRAILINGSTEUN		Geslepen
316		
14.9063.321.12		2

NEW

QS-50 348 / QS-87 351

Te combineren met handrailingadapter 14.0930.115.12.

Handrailingsteun

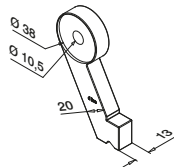
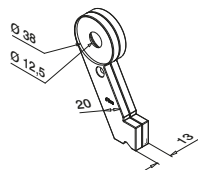

MIDDEN	Glasgestraald	
HANDRAILINGSTEUN		
316		
14.9030.136.01		2

EIND	Glasgestraald	
HANDRAILINGSTEUN		
316		
14.9030.125.01		2

NEW

Klemring

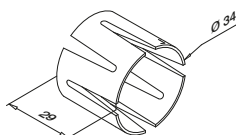

Ø 34	Aluminium	
KLEMRING		
16.9030.230.00		2

NEW



Klemkoon

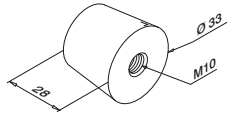

$\varnothing 33$	Messing
KLEMKON	
09.9030.245.00	2
NEW	

Baluster

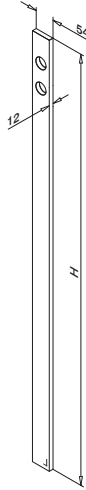

	Geslepen
BALUSTER	
316	H
14.9030.040.12	1200 (900) 1
14.9030.045.12	1400 (1100) 1
NEW	

Afdekkap

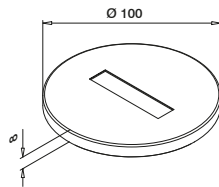

$\varnothing 100$	Geslepen
AFDEKKAP	
316	
14.9030.660.12	2
NEW	

Omnibend, afstandsring

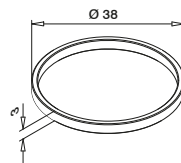

$\varnothing 38$	Glasgestraald
OMNIBEND, AFSTANDSRING	
316	
14.9030.215.01	15
NEW	

Omnibend, afstandsstuk

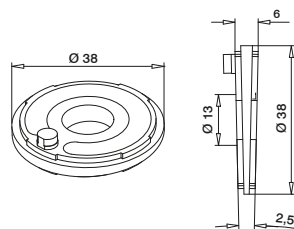

$\varnothing 38$	
OMNIBEND, AFSTANDSSTUK	
24.9030.210.00	14
NEW	

Afstandsstuk

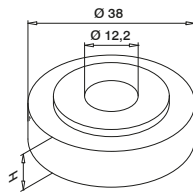
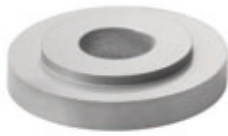

Ø 38	Glasgestraald	
AFSTANDSSTUK		
316	H	
14.9047.005.01	5	2
14.9047.010.01	10	2

NEW

QS-550 113

Voor wandmontage

Schroef

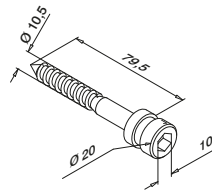

SCHROEF			
316	QS	L	
19.9037.510.14	QS-550	100	10

NEW

Voor wandmontage

Afstandsring

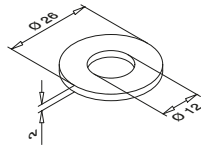

AFSTANDSRING		
316	QS	
93.0301.226.14	QS-546	10

NEW

te gebruiken met QS-550